

Райтон

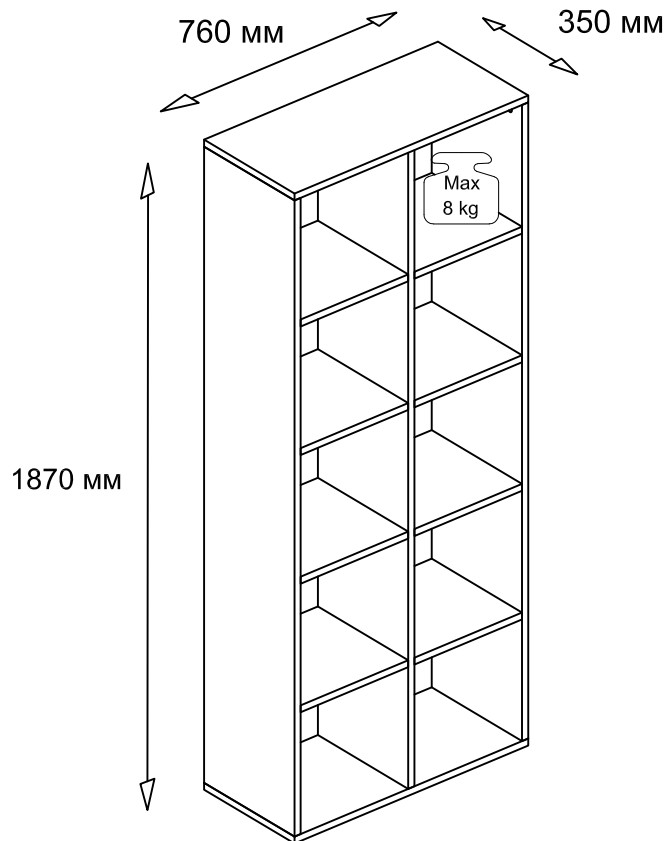

- | | |
|----------------------------------|------------------------------|
| (D) Montageanleitung | (GB) Assembly instructions |
| (FR) Notice de montage | (IT) Istruzioni di montaggio |
| (NL) Handleiding voor de montage | (PL) Instrukcja montażu |
| (CZ) Montážní návod | (SK) Návod na montáž |
| (HU) Szerelési útmutató | (RO) Instrucțiuni de montaj |
| (TR) Montaj talimatları | (RU) Инструкция по монтажу |

45 min

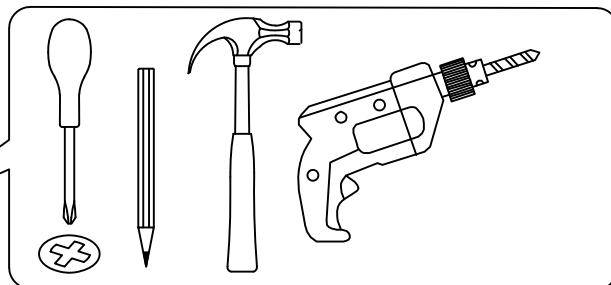
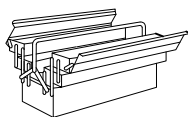
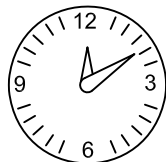
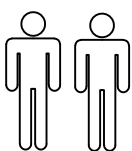

Name • Nom • Nome • Naam • Nazwa • Jaméno
 • Názov • Név • Denumire • Isim • Название

Nr. • No. • N° • Номер • Č • Sz

Typ • Type • Tip • Tipus • Tipo • Тип

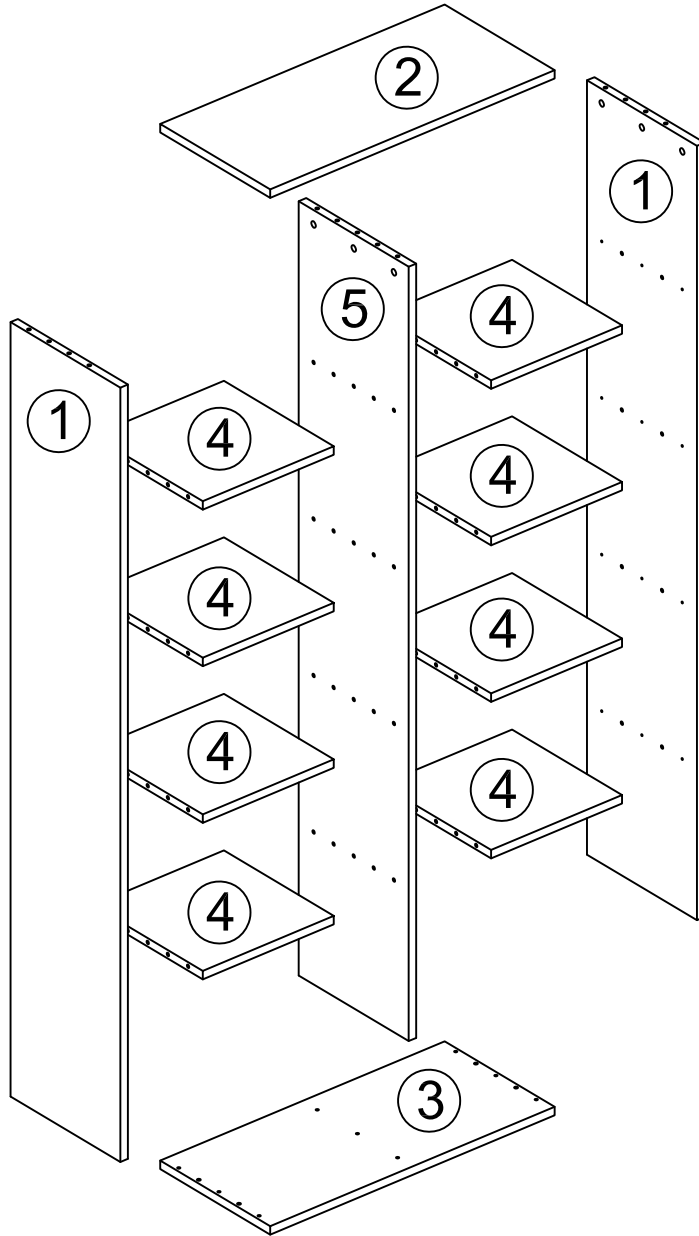
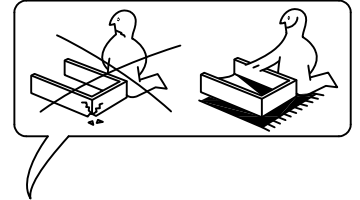
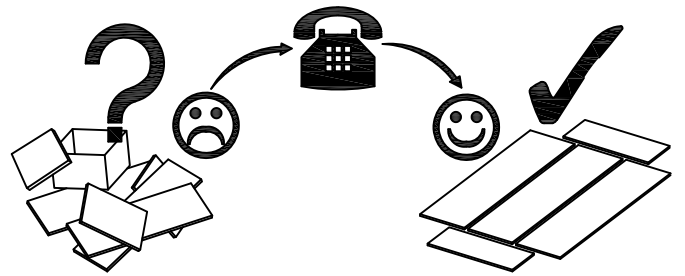
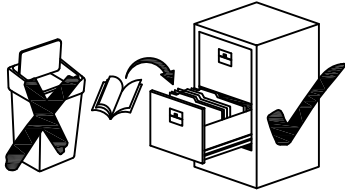

A1 | x9

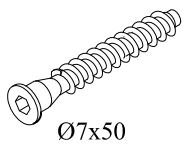

Ø7x50

O1 | x1

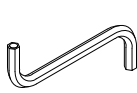

S 4 mm

K1 | x44

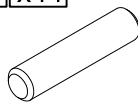

Ø8x35

B1 | x33

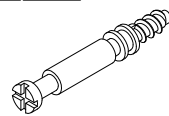

C1 | x57

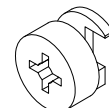

Ø15

B2 | x12

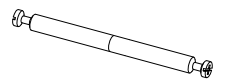

P1 | x1

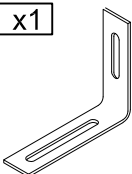

G1 | x1

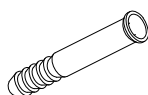

Ø6x60

V1 | x1

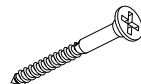

J2 | x2

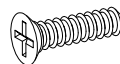

4x16

R1 | x5



No	Size/MaB	Qty	✓
1	1830x350x20	2	
2	760x350x20	1	
3	760x350x20	1	
4	350x350x20	8	
5	1830x350x20	1	

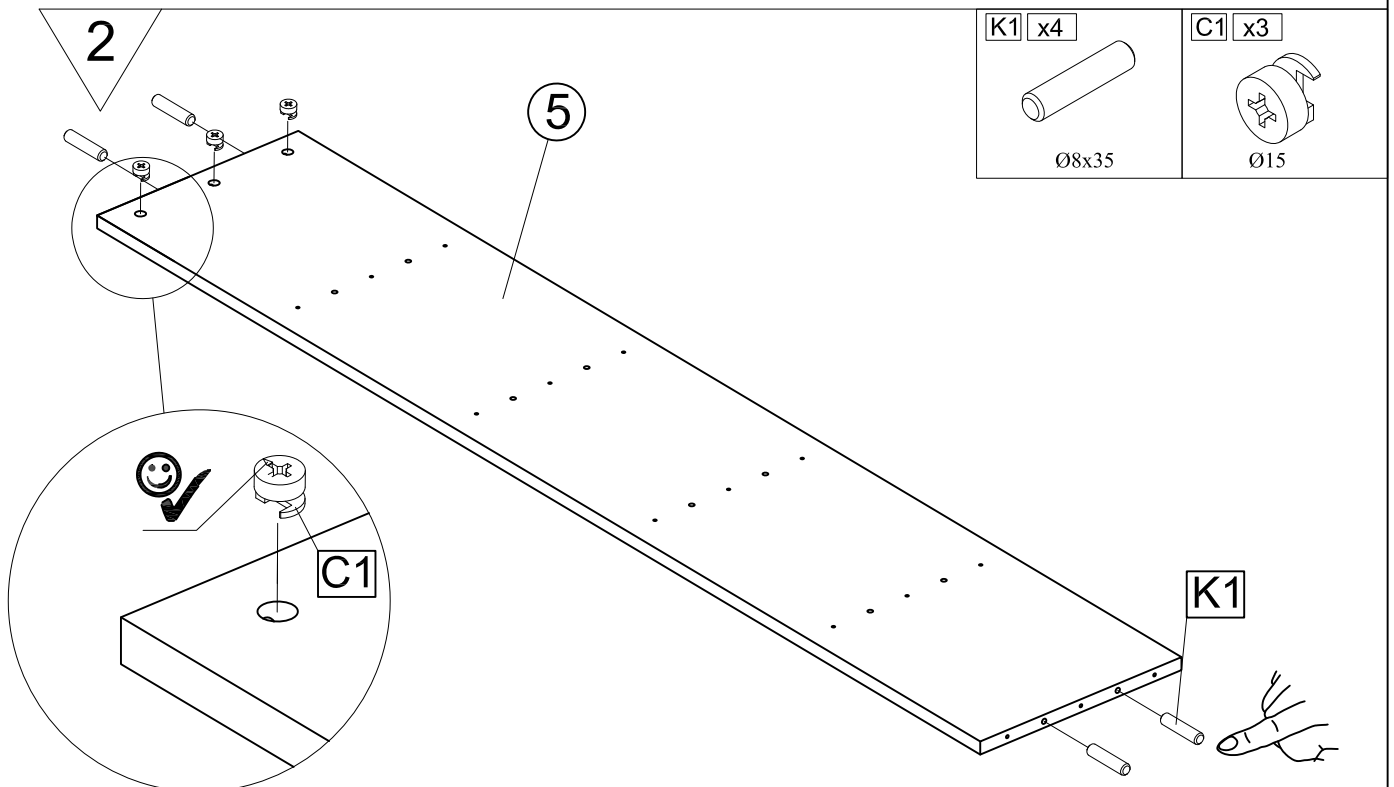
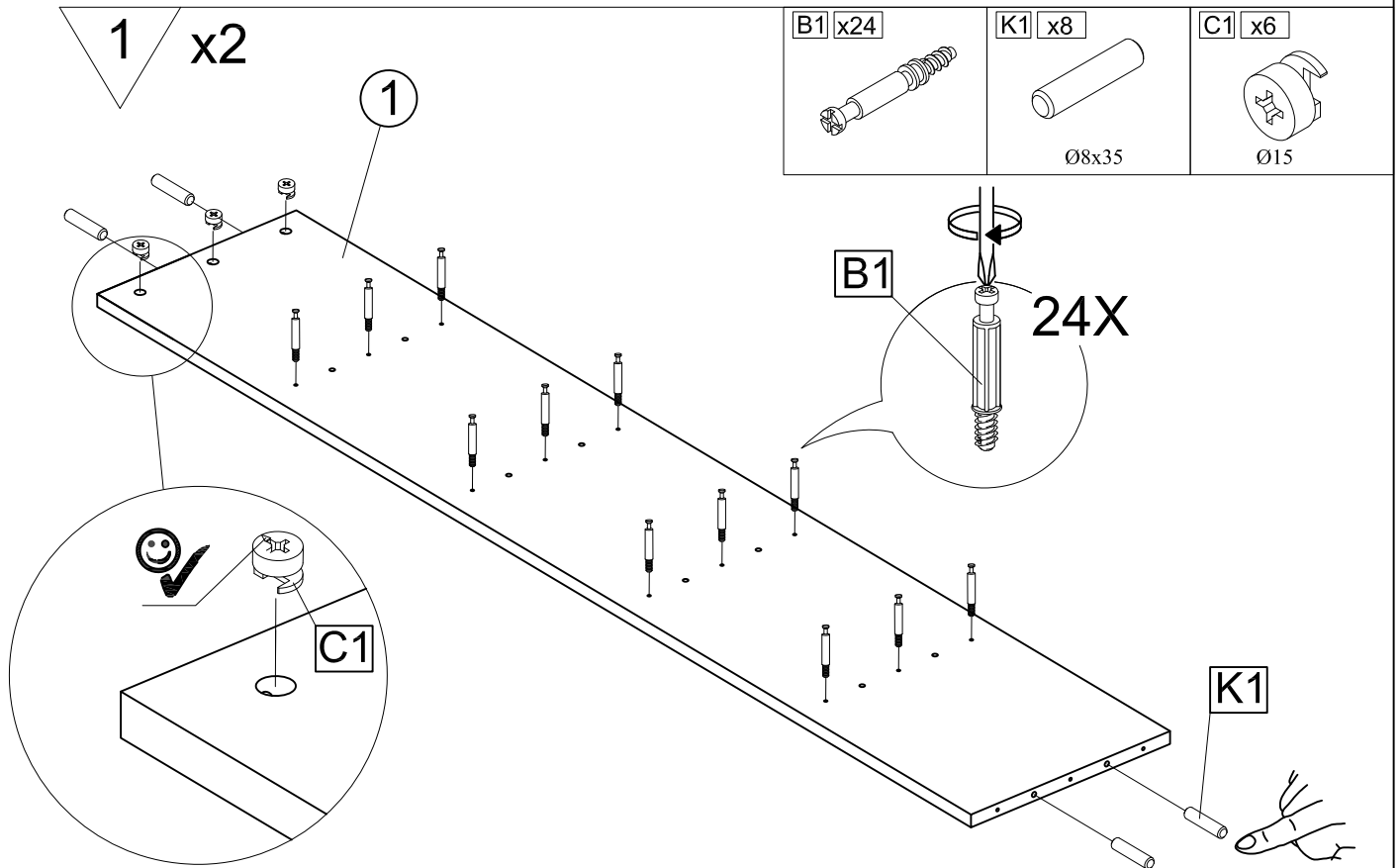

3 x8

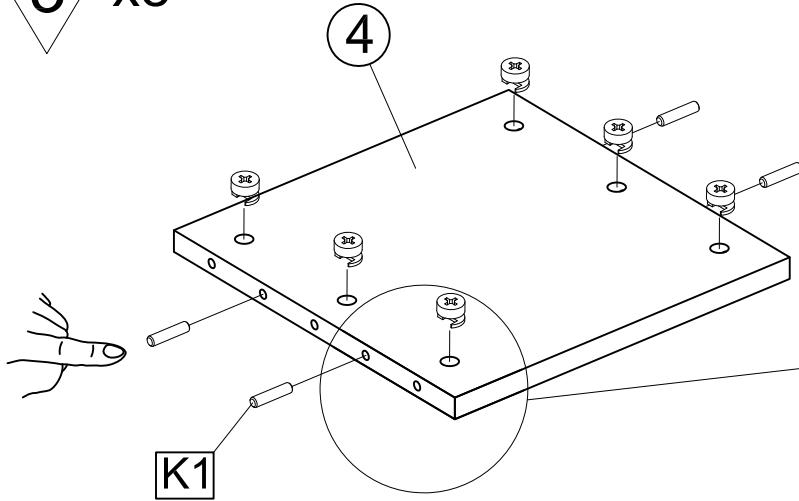

K1 x32

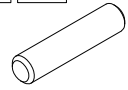

Ø8x35

C1 x48



Ø15

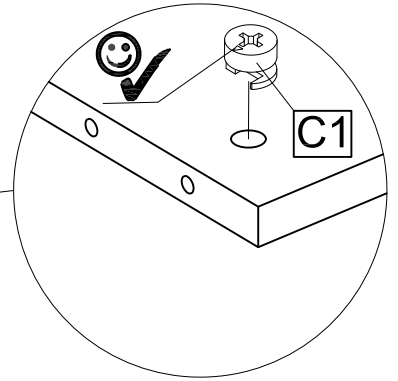

4

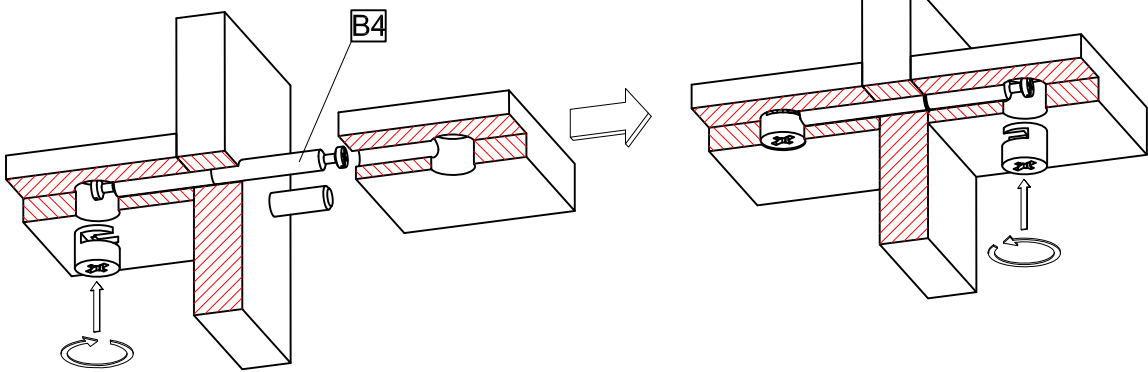

B2 x12

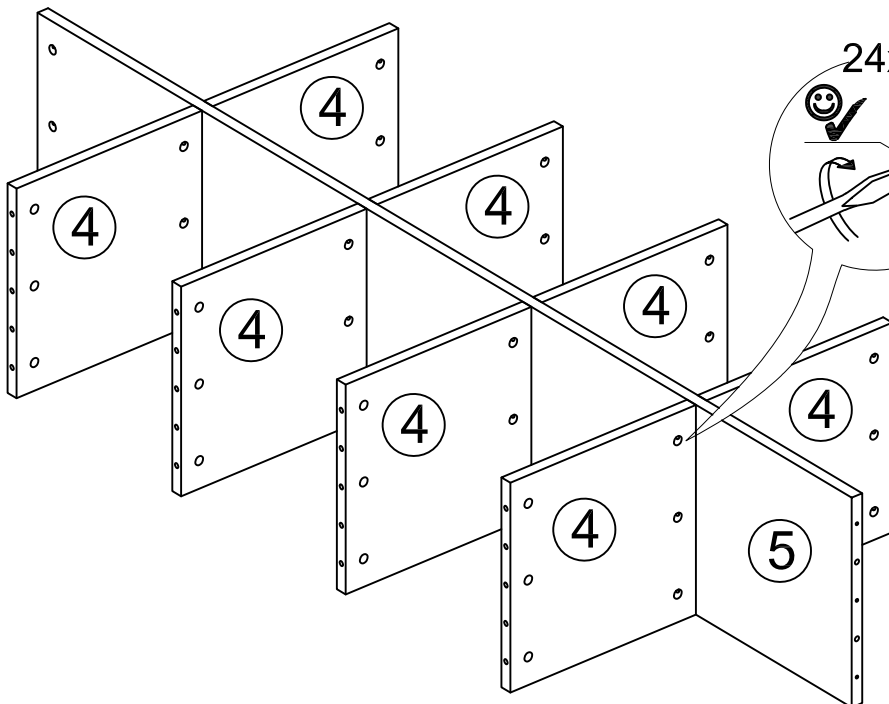
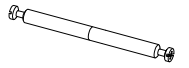

5

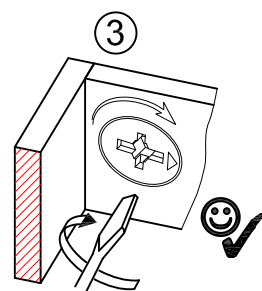
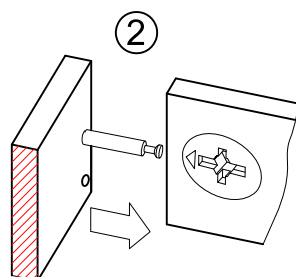
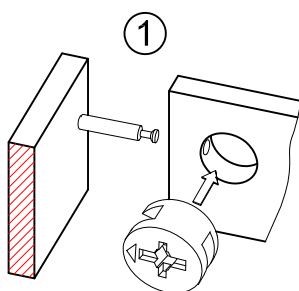
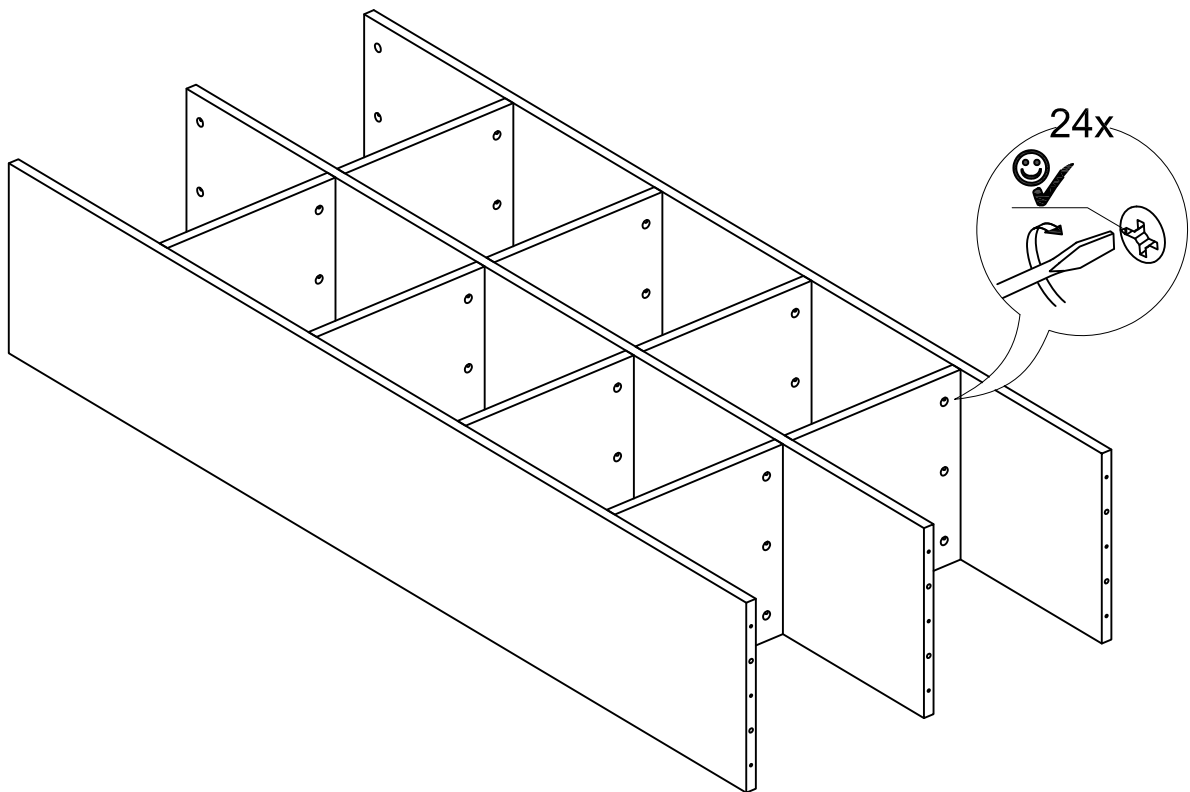
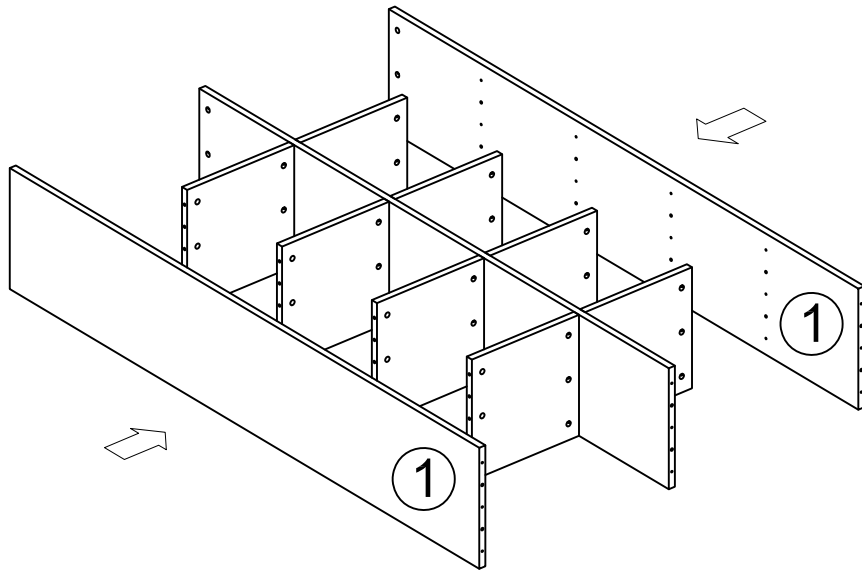

6

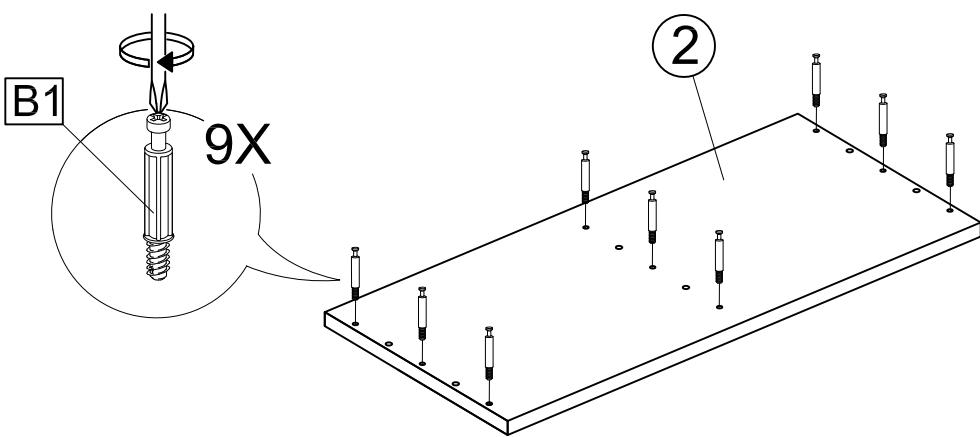

B1 x9

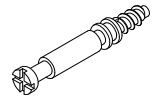

7

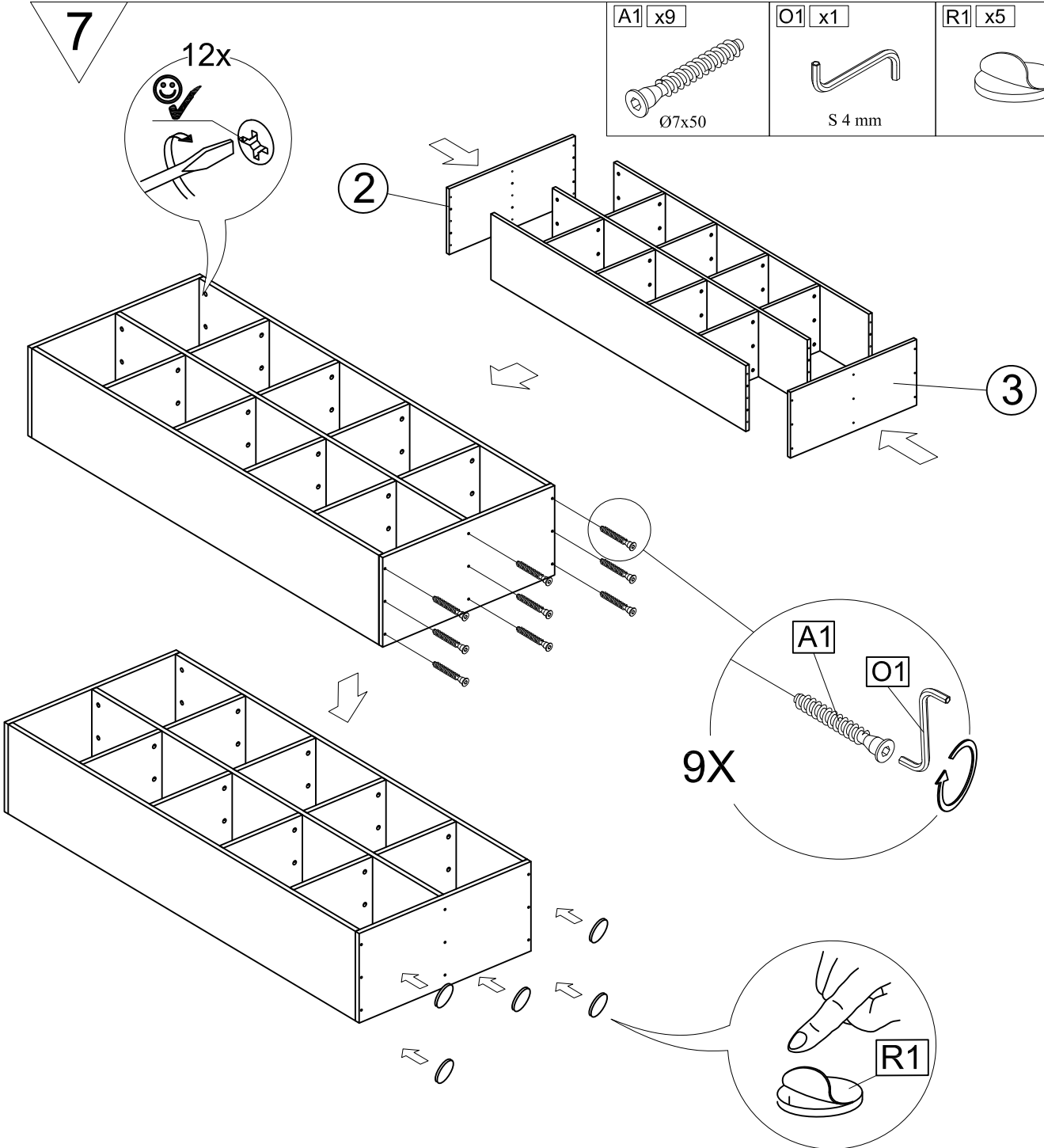

A1 x9

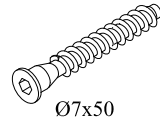

Ø7x50

O1 x1

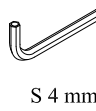

S 4 mm

R1 x5



9X

R1

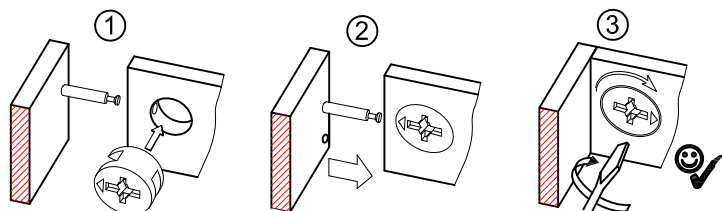

8

J2 x2



4x16

P1 x1

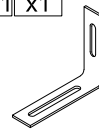

G1 x1

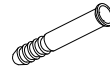

V1 x1

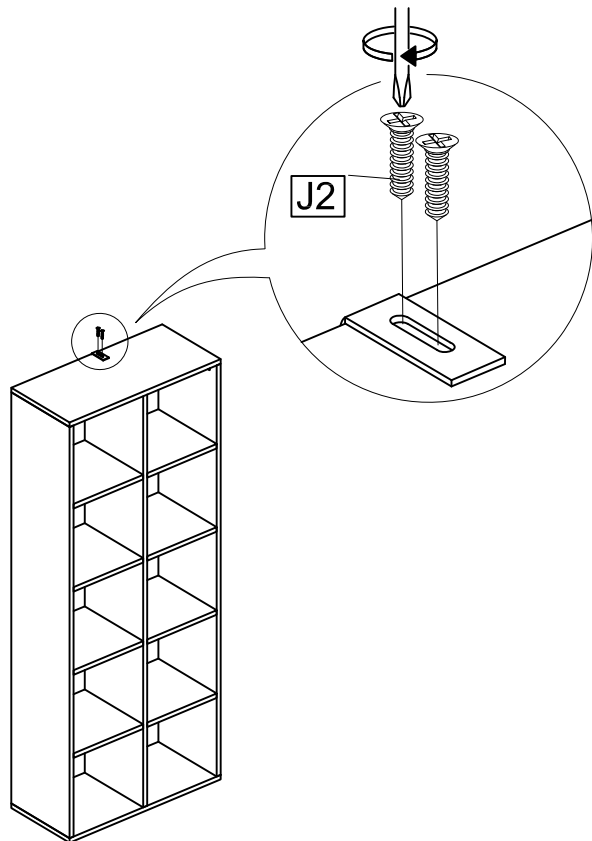
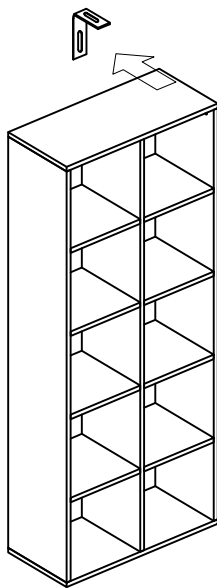
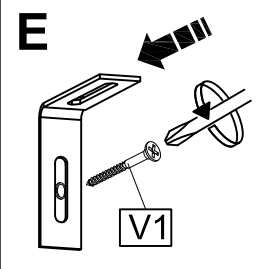
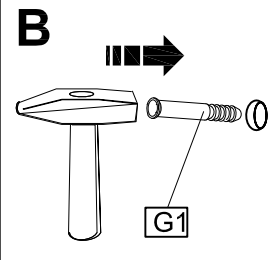
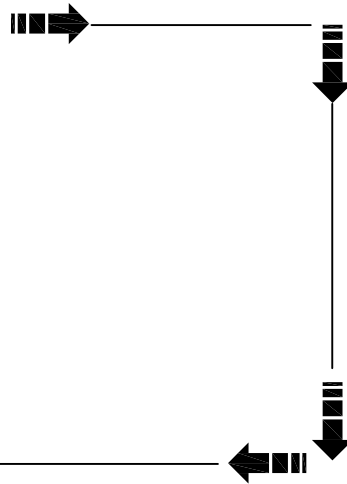
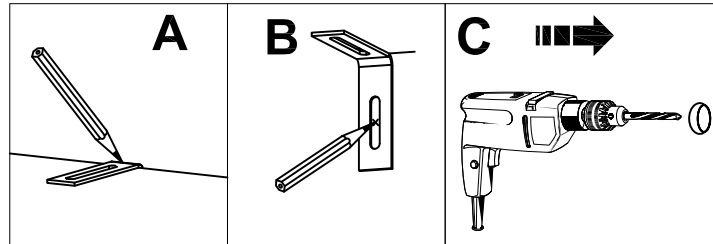
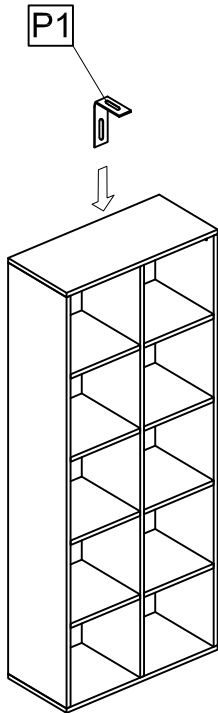



Achtung • Attention • Attenzione
Opgelet • Uwaga • Pozor • Figyelem
Atenție • Dikkat • Внимание



(D)	Wandbefestigung dient als Kippschutz - unbedingt anbringen! Bei einigen Wandtypen kann ein Spezialdübel erforderlich sein!
(GB)	The wall fastening serves to prevent tipping - be absolutely sure to mount it! For certain wall types, a special wall plug may be necessary!
(FR)	La fixation murale sert de protection contre le basculement - à installer impérativement ! Pour certains types de murs il faut des chevilles spéciales !
(IT)	Il fissaggio alla parete serve da protezione anti-ribaltamento - attaccarla assolutamente! Per alcune strutture di parete può essere necessario un tassello speciale!
(NL)	Bevestiging aan de muur dient als kantelbescherming - zeker en vast bevestigen! Bij enkele muurtypes is een speciale plug misschien vereist!
(PL)	Mocowanie do ściany jest jednocześnie zabezpieczeniem przed przewróceniem - koniecznie zamontować! Do niektórych rodzajów ścian koniecznie zastosować specjalne kołki mocujące.
(CZ)	Montáž na stěnu slouží jako ochrana proti převrnutí - bezpodmi- nečně umístěte! U některých typu stěn může být zapotřebí speci- ální hmoždinka!
(SK)	Upevnenie na stenu slúži ako ochrana proti prevráteniu - bezpod- mienečne použite! Pre niektoré druhy stien môže byť potrebná špeciálna hmoždinka!
(HU)	A terméket a falhoz kel rögzíténi, különben az felborulhat! Egyes faltípusoknál speciális tiplit kell használni!
(RO)	Sistemul de fixare la perete servește ca protecție la răsturnare - de montat obligatoriu! Pentru unele tipuri de pereți este posibil să fie necesar un diblu special!
(TR)	Duvardaki sabitleme, devrilmeye karşı bir emniyet tedbiridir ve mutlaka monte edilmelidir! Bazı duvar tiplerinde bunun için özel bir dübel gerekli olabilir!
(RU)	Обязательно установите крепление к стене во избежание опрокидывания ! Для некоторых типов стен может потребо- ваться специальный дюбель!